



TYPE - A



**Innhold / Content**

- 6-7 Husets historie / *Story of the house***
- 8-11 Less is more (Enkelt er bra) / *Less is more***
- 12-15 Å være ett med naturen, å være i naturen / *To be with nature, to be in nature***
- 16-27 Det perfekte ses i detaljen / *God is in the details***
- 28-31 Husets detaljer / *House details***





## Husets historie / Story of the house

---

Husets historie handler om frihet. Huset er designet for å tjene mennesker, ikke vice versa. Det handler om å bryte grenser, der hus og skog smelter sammen gjennom glassveggen. Historien handler om å være tilstede og oppleve ektheden rundt deg . Prøv å forestill deg å ligge i sengen og se stjerneskyer eller drikke morgenkaffen på verdens største terrasse i skyggen av grenene.

**This house story is all about freedom. The house is designed to serve people but not visa versa. It is all about braking boundaries, where through the glass wall the house and forest merge into one. The story is about how to be close by and to experience everything for real. Just imagine to sleep in the bed watching falling stars or to drink morning coffee at the world biggest terraces in the shade of branches.**



## Less is more (Enkelt er bra) / Less is more

Målene kan gi det inntrykk at det er et lite hus, men planløsning og romdimensjon viser seg å være det motsatte.

Det er innrettet slik at det kommer masse dagslys inn i stuen, romslig dusj og toalett, kjøkken ved siden av med spisebord.

Plass til en stor dobbeltseng er utformet på andre nivå rett under himmelen full av stjerner, noe som totalt sett er et perfekt avslapningssted for familien på fire medlemmer. Det er mulig å kopple på et ekstra soverom eller badstueblokk på huset.

**Numbers give an impression that the house is small however layout and space width will prove an opposite.**

**There are accommodated filled with light space for the living room, spacious shower and toilet, kitchen is placed next to dining table. Space for a big double-bed is designed on the second level just below sky full of stars, what in overall makes a perfect relaxation place for the family of four members. Growing larger, there is a possibility to add a second bedroom or sauna block.**

bedroom or sauna block.

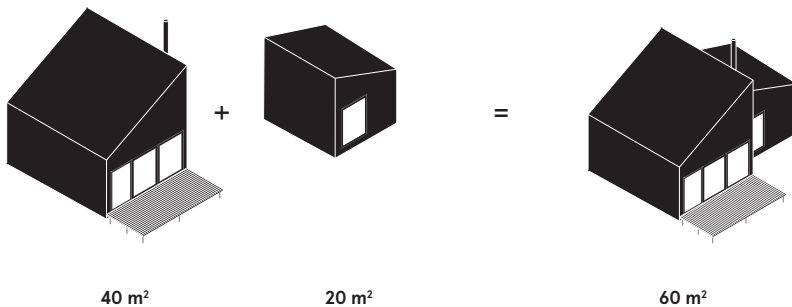



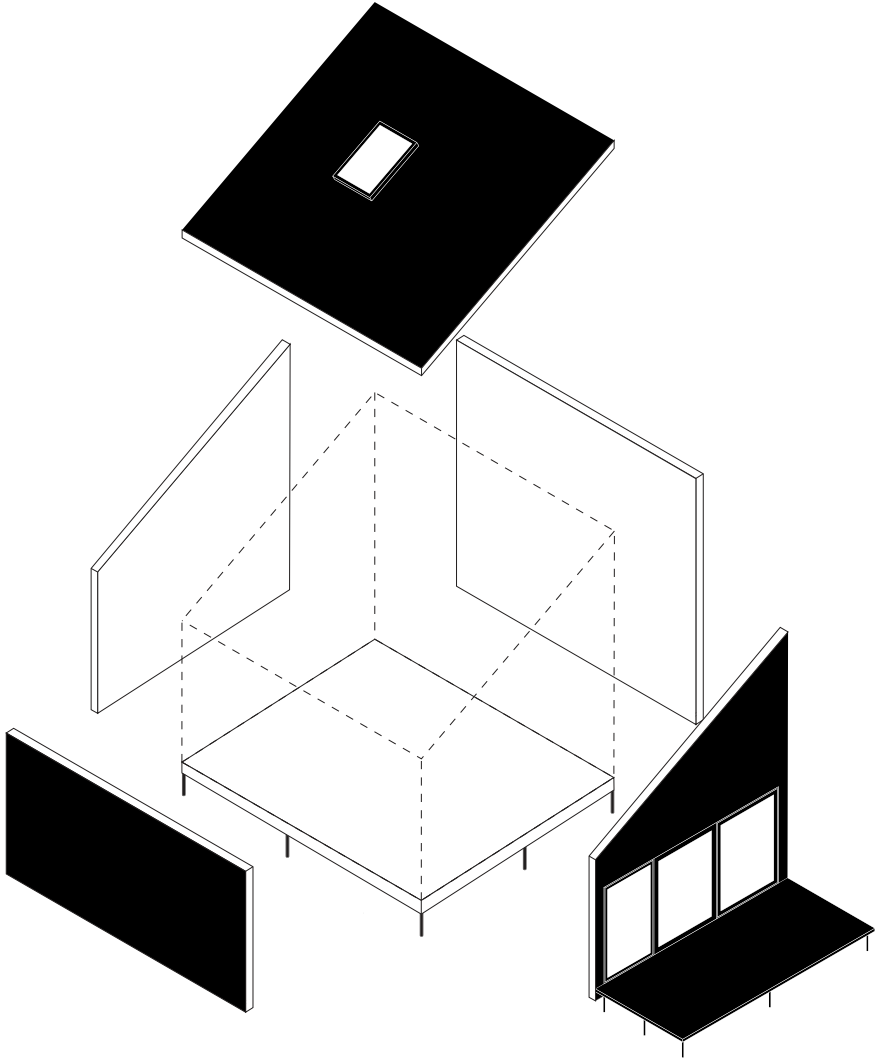





**Å være ett med naturen, å være i naturen / To be with nature, to be in nature**

---

Du bør vise hensyn til naturen. Du bør være en del av den, Bygningen som heves fra bakken er laget av massive trepaneler, samt naturlige tregulv, trevinduer og dører. Fasadens svarte glansteknikk er inspirert og kommer fra gamle vikingtradisjoner, noe som gjør huset holdbart.

**You should be considerate with nature. You should be a part of it. The building which is removed from the ground is made from a solid wood panels with addition of natural wooden floors, wooden windows and doors. The façade's black shine technique is inspired and come from Old Vikings traditions, which makes house long-lasting.**









## Det perfekte ses i detaljen / God is in the details

---

Møblene som er spesielt laget for huset lar deg få mest mulig ut av rommet. Et romslig kjøkken, en stor garderobe, et hyllesystem under trappene og en stor bod på øverste etasje av bygningen sikrer at det blir nok plass til eiendeler slik at ditt daglige oppholdsrom vil være fritt for rot og ha masse lys. Hver detalj er nøye gjennomtenkt og perfektionert over tid, slik at du kan glemme den tunge byggeprosessen og ofte komplekse konstruksjonen.

**The furniture created for this house allows you to get the most out of the room. A spacious kitchen, a large wardrobe, a shelving system underneath the stairs, and a large storage room on the second level of the building - all this ensures that there will be enough space for belongings, but your daily living space will be clean of clutter and full of light. Every detail has been carefully thought out and perfected over time, allowing you to forget about the heavy building**

**process and the often complex construction.**



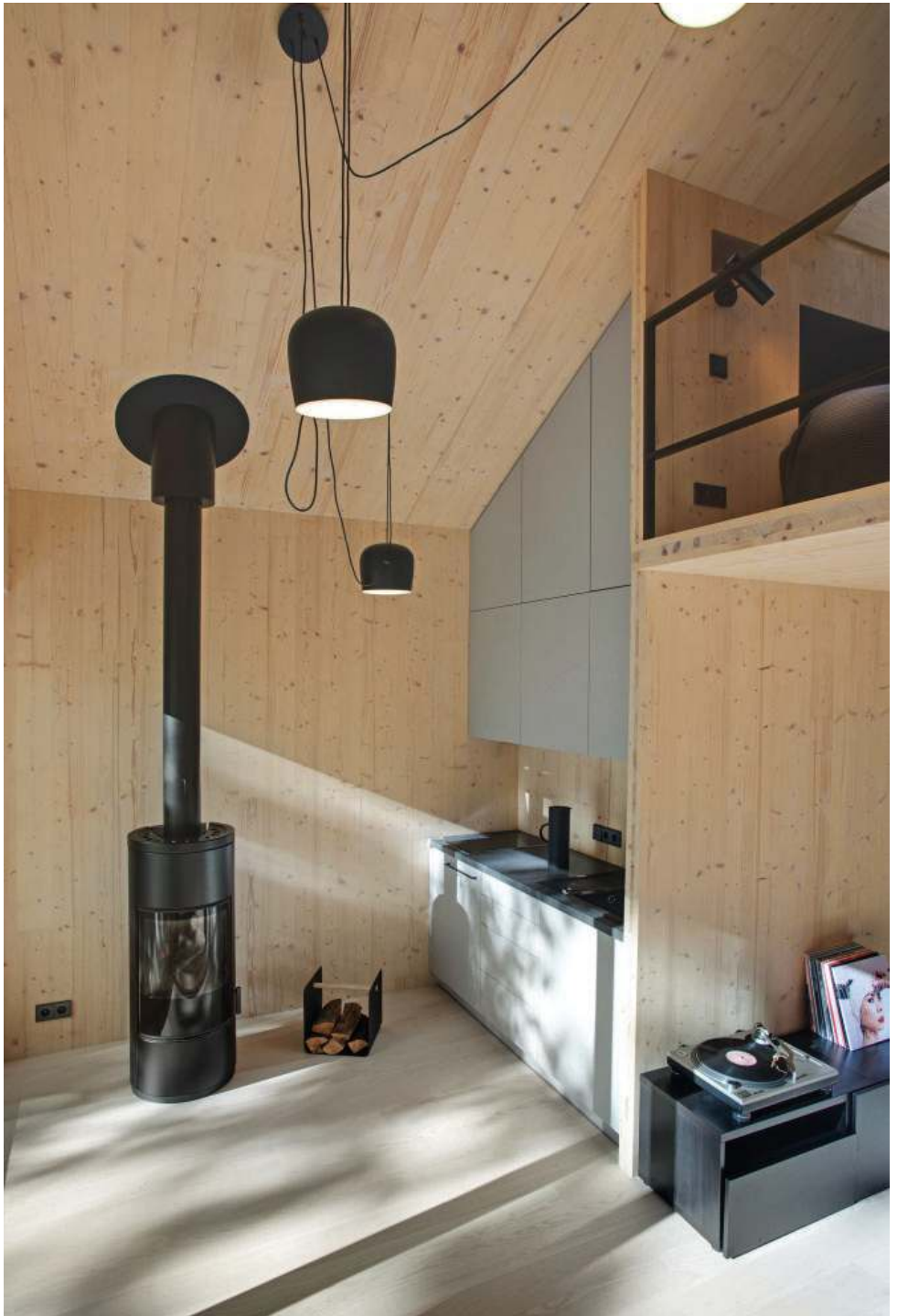

Plan for første etasje / First floor plan

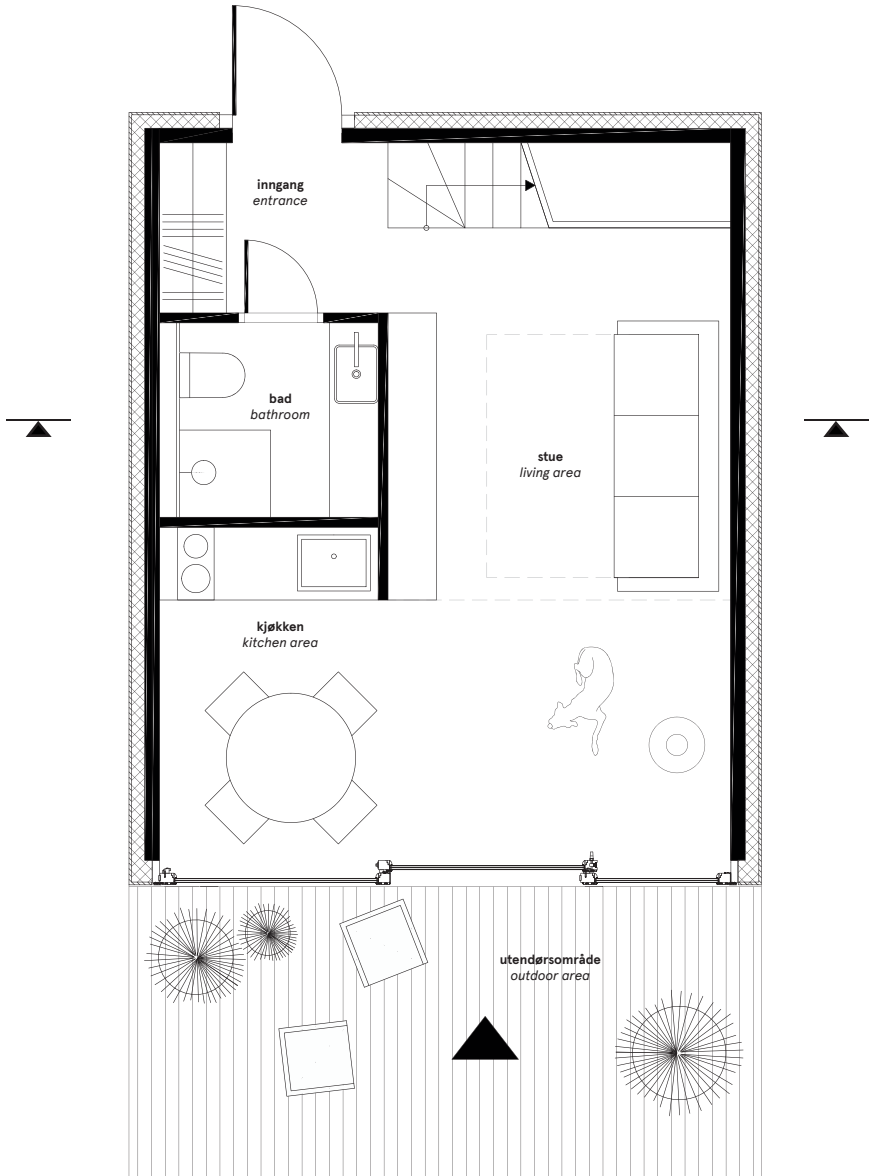

Plan for andre etasje / Second floor plan

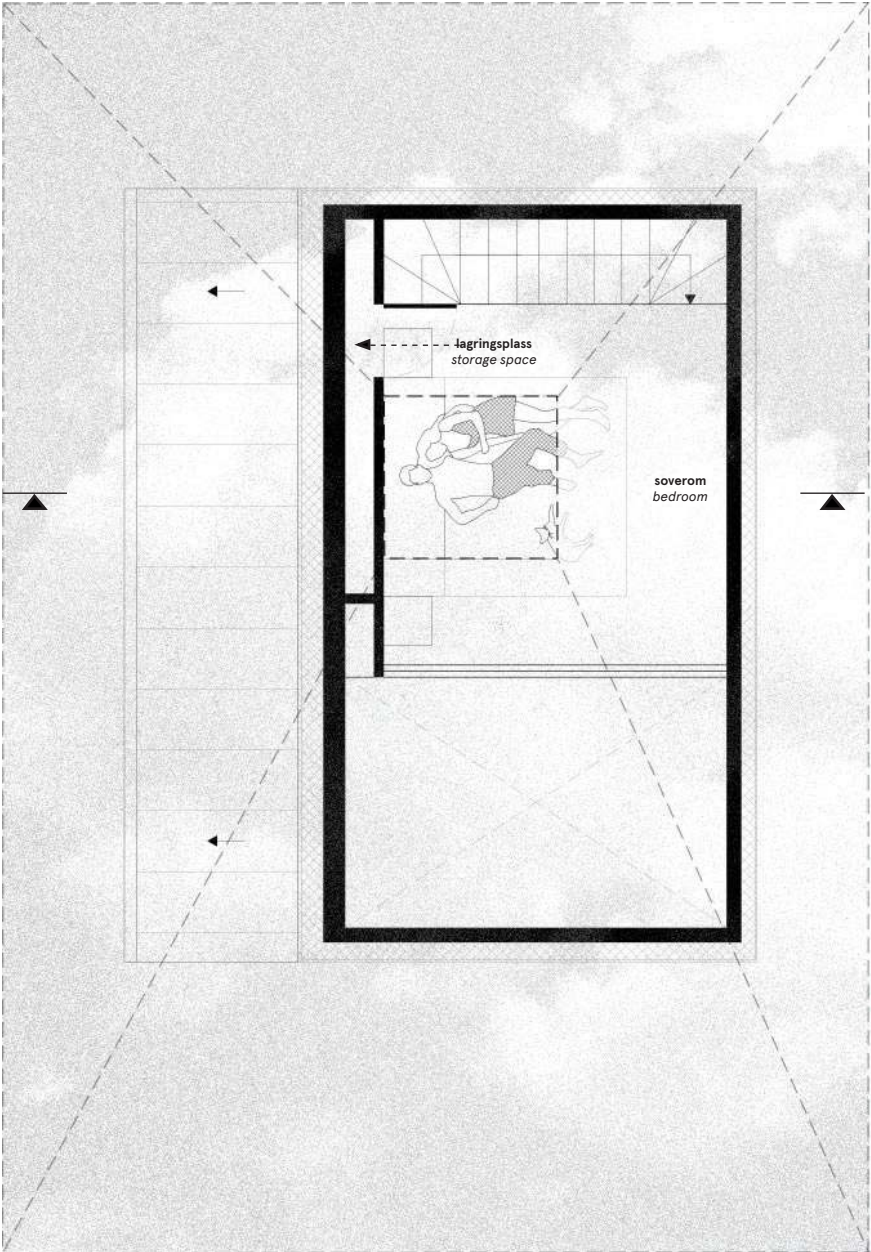

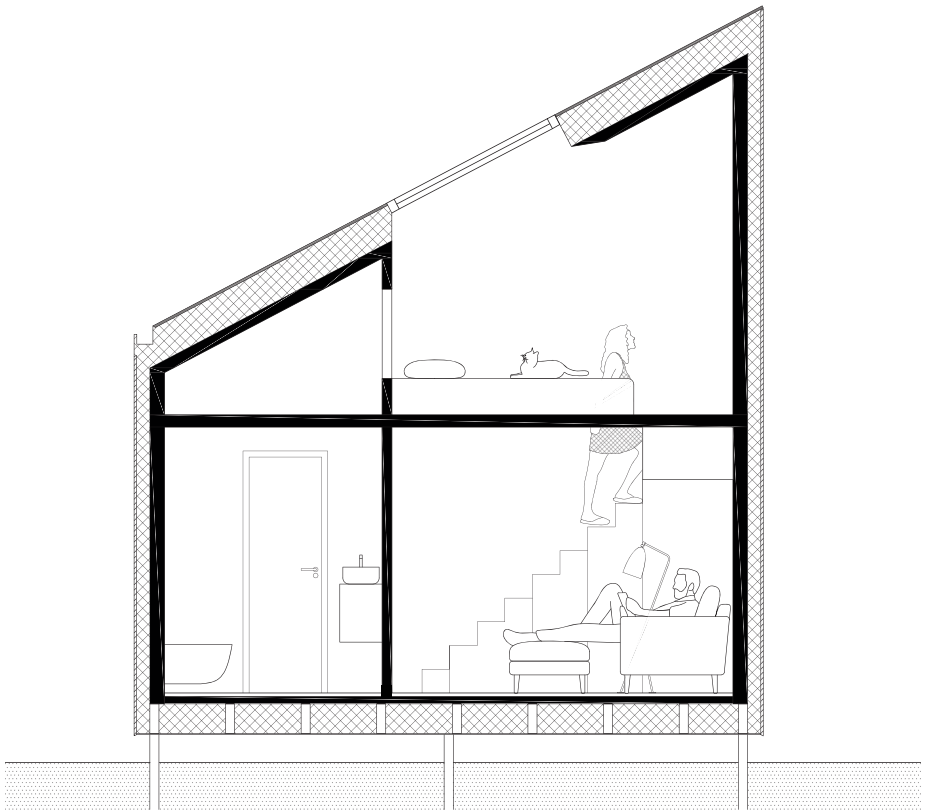

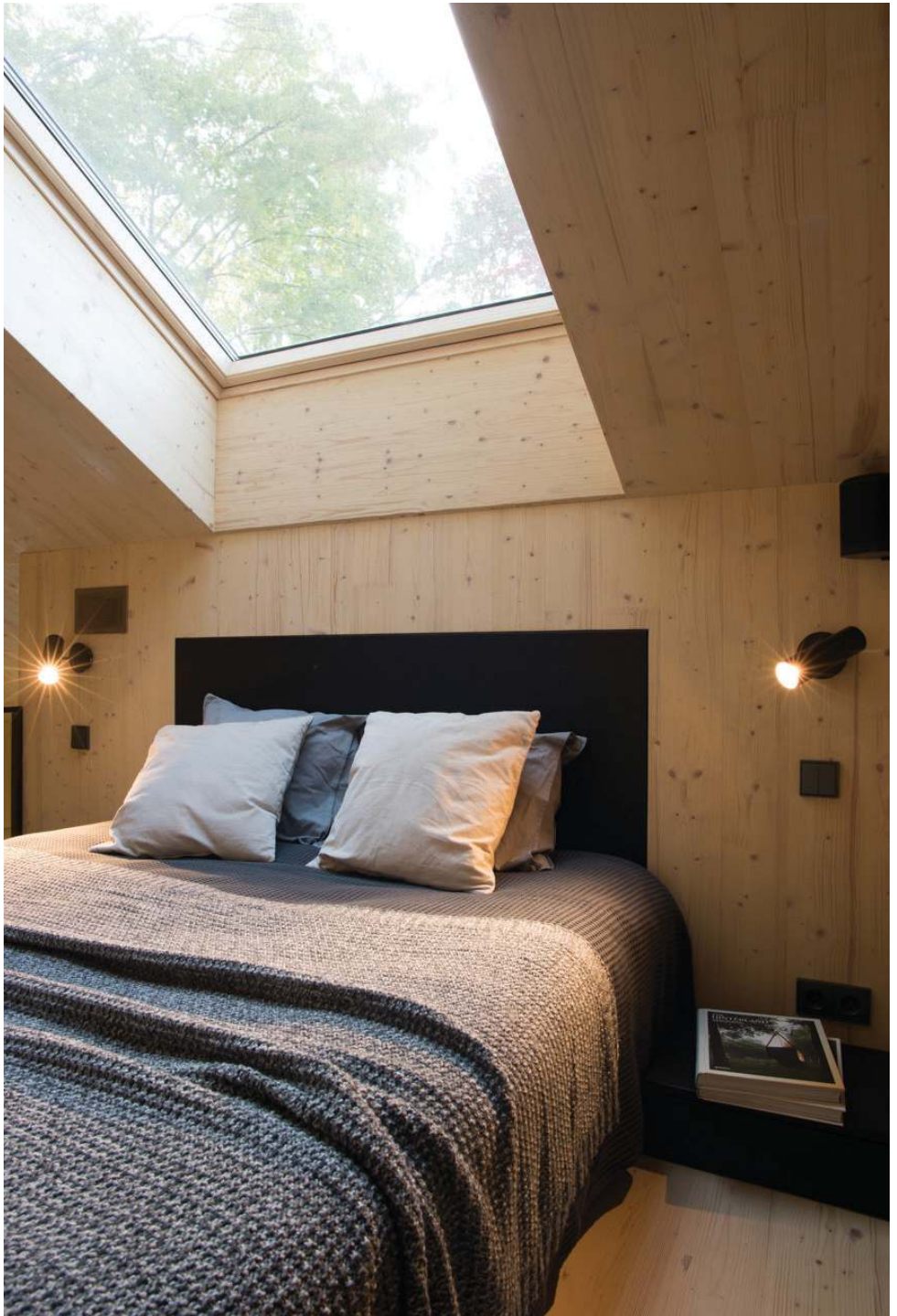







Inngang / Entrance





**Bad / Bathroom**





## Husets detaljer / House details

---

Forhåndsfabrikkerte bygningselementer tillater montering av bygningen på en dag. Alle materialene som brukes er miljøvennlige og er laget med høyeste presisjon. Det gir et resultat som er en nytelse for øyet og har en ekstra touch. Så alt du trenger å gjøre er å nyte friheten, gå ut i naturen og kjenne energistrømmen strømme mot dig. Du vil vite med sikkerhet at det alltid er et trygt, roligt og vakkert sted å komme tilbake til - ditt hjem.

**Prefabricated building elements allow assembling building in one day. All materials used are environmentally friendly and made with the highest precision, resulting in an image that is pleasing to the eye and the touch of a hand.**

**So what is left for you is to enjoy the freedom, to go to nature, and feel energy flow coming in.**

**You will know for sure that there is always a place to come back - your home.**

### Legende / Legend



**Krysslaminert tre (CLT) / Cross laminated timber (CLT)**



**Oppsaget tømmer / Sawn timber**



**Termoisolasjon / Thermo insulation**



**Trelags parkett / Three layered parquet**



**Fliser / Tiles**



**Falmet ståltak / Seamed steel roofing**



**Fasadebord i lerk og malt med tjæremaling i "tar balack" / Larch finishing boards painted with tar paint in tone "tar balack"**

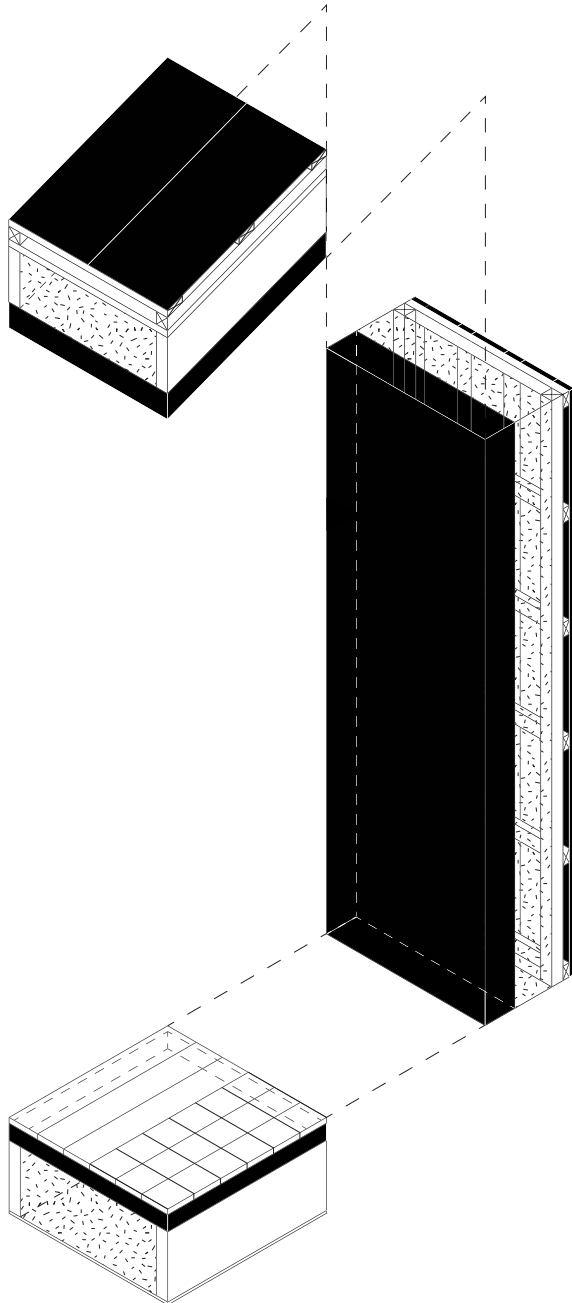

**Konstruksjonsdetaljer /**  
*Construction details*



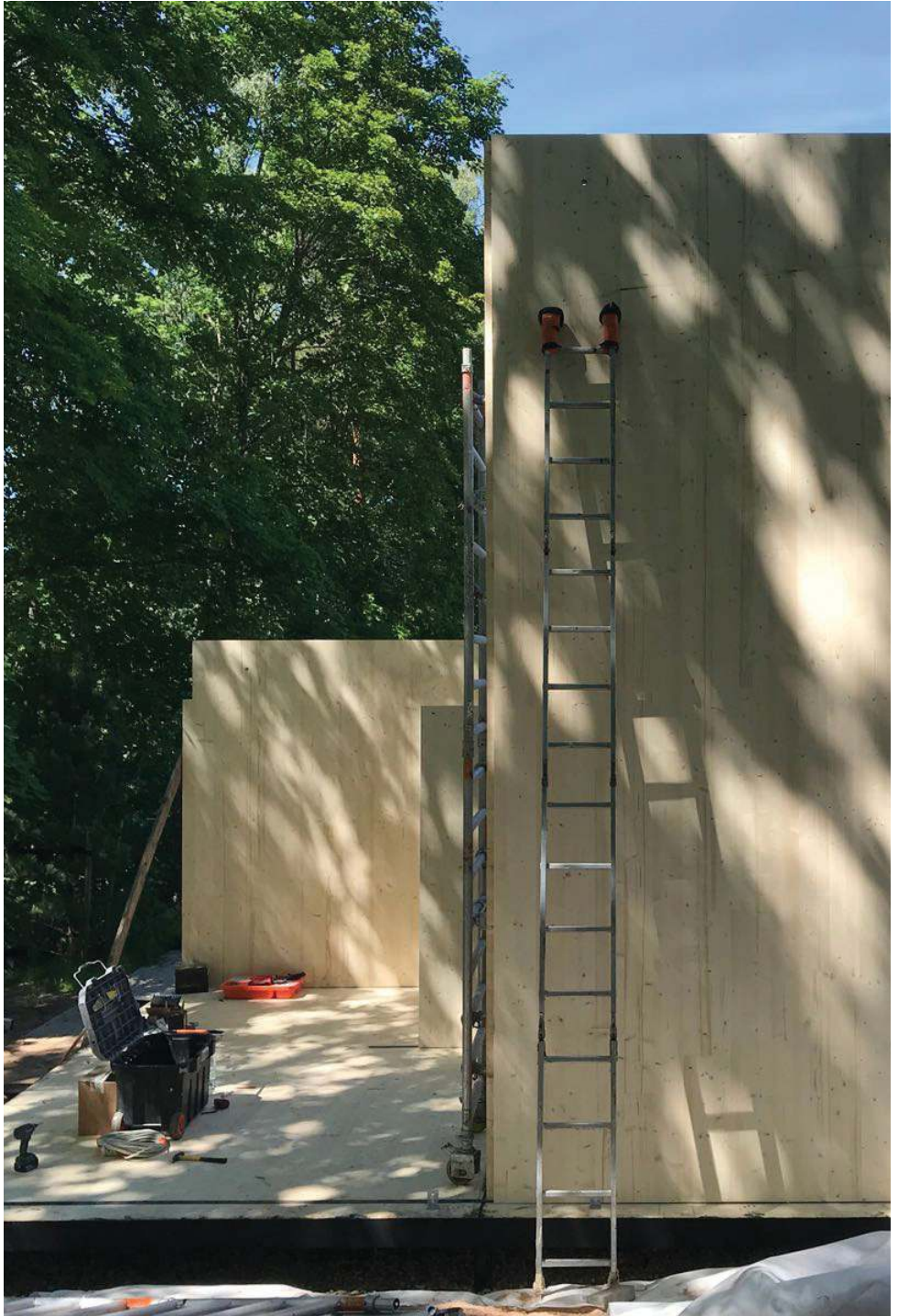









TYPE - C